

PESD1LIN

LIN bus ESD protection diode in SOD323

Rev. 01 — 26 October 2004

Product data sheet

1. Product profile

1.1 General description

PESD1LIN in very small SOD323 (SC-76) SMD plastic package designed to protect one automotive LIN bus line from the damage caused by ElectroStatic Discharge (ESD) and other transients.

1.2 Features

- ESD protection of one automotive LIN bus line
- Asymmetrical diode configuration ensures an optimized Electromagnetical Immunity of a LIN Electronic Control Unit (ECU)
- Due to the integrated diode structure only one very small SOD323 package is needed
- Max. peak pulse power: $P_{PP} = 160 \text{ W}$ at $t_p = 8/20 \mu\text{s}$
- Low clamping voltage: $V_{(CL)R} = 40 \text{ V}$ at $I_{PP} = 1 \text{ A}$
- Ultra low leakage current: $I_{RM} < 1 \text{ nA}$
- ESD protection of up to 23 kV
- IEC 61000-4-2, level 4 (ESD)
- IEC 61000-4-5 (surge); $I_{PP} = 3 \text{ A}$ at $t_p = 8/20 \mu\text{s}$

1.3 Applications

- LIN bus protection
- Automotive applications

1.4 Quick reference data

Table 1: Quick reference data

Symbol	Parameter	Conditions	Min	Typ	Max	Unit
V_{RWM}	reverse stand-off voltage					
	PESD1LIN (15 V)		-	-	15	V
	PESD1LIN (24 V)		-	-	24	V
C_d	diode capacitance	$V_R = 0 \text{ V};$ $f = 1 \text{ MHz}$	-	13	17	pF

PHILIPS

2. Pinning information

Table 2: Pinning

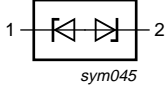
Pin	Description	Simplified outline	Symbol
1	cathode 1 (15 V)		
2	cathode 2 (24 V)		

3. Ordering information

Table 3: Ordering information

Type number	Package		
	Name	Description	Version
PESD1LIN	SC-76	plastic surface mounted package; 2 leads	SOD323

4. Marking

Table 4: Marking codes

Type number	Marking code
PESD1LIN	AM

5. Limiting values

Table 5: Limiting values

In accordance with the Absolute Maximum Rating System (IEC 60134).

Symbol	Parameter	Conditions	Min	Max	Unit
P_{PP}	peak pulse power	8/20 μ s	[1] -	160	W
I_{PP}	peak pulse current	8/20 μ s	[1] -	3	A
T_j	junction temperature		-	150	$^{\circ}$ C
T_{amb}	ambient temperature		-65	+150	$^{\circ}$ C
T_{stg}	storage temperature		-65	+150	$^{\circ}$ C

[1] Non-repetitive current pulse 8/20 μ s exponentially decaying waveform; see [Figure 1](#).

Table 6: ESD maximum ratings

Symbol	Parameter	Conditions	Min	Max	Unit
ESD	electrostatic discharge capability	IEC 61000-4-2 (contact discharge)	[1] -	23	kV
		HBM MIL-STD883	-	10	kV

[1] Device stressed with ten non-repetitive ElectroStatic Discharge (ESD) pulses; see [Figure 2](#).

Table 7: ESD standards compliance

ESD Standard	Conditions
IEC 61000-4-2, level 4 (ESD); see Figure 2	> 15 kV (air); > 8 kV (contact)
HBM MIL-STD883, class 3	> 4 kV

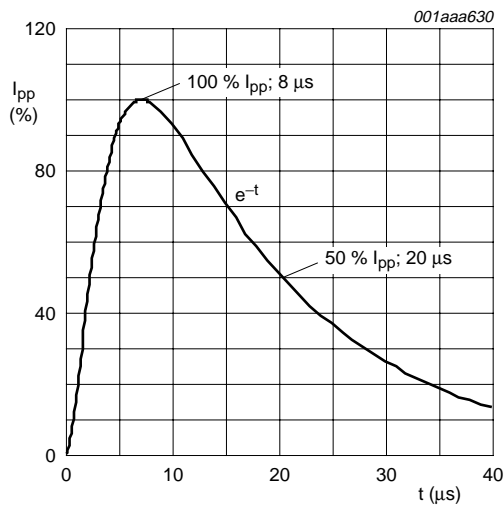

Fig 1. 8/20 μs pulse waveform according to IEC 61000-4-5.

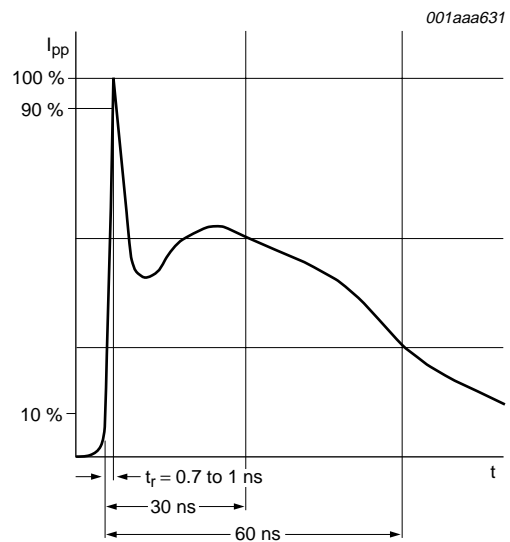

Fig 2. ElectroStatic Discharge (ESD) pulse waveform according to IEC 61000-4-2.

6. Characteristics

Table 8: Characteristics

$T_{amb} = 25\text{ }^{\circ}\text{C}$ unless otherwise specified.

Symbol	Parameter	Conditions	Min	Typ	Max	Unit
V_{RWM}	reverse stand-off voltage					
	PESD1LIN (15 V)		-	-	15	V
	PESD1LIN (24 V)		-	-	24	V
I_{RM}	reverse leakage current					
	PESD1LIN (15 V)	$V_{RWM} = 15\text{ V}$	-	< 1	50	nA
	PESD1LIN (24 V)	$V_{RWM} = 24\text{ V}$	-	< 1	50	nA
$V_{(BR)}$	breakdown voltage	$I_R = 5\text{ mA}$				
	PESD1LIN (15 V)		17.1	18.9	20.3	V
	PESD1LIN (24 V)		25.4	27.8	30.3	V
C_d	diode capacitance	$V_R = 0\text{ V}; f = 1\text{ MHz}$	-	13	17	pF
$V_{(CL)R}$	clamping voltage		[1]			
	PESD1LIN (15 V)	$I_{PP} = 1\text{ A}$	-	-	25	V
		$I_{PP} = 5\text{ A}$	-	-	44	V
	PESD1LIN (24 V)	$I_{PP} = 1\text{ A}$	-	-	40	V
		$I_{PP} = 3\text{ A}$	-	-	70	V
r_{dif}	differential resistance					
	PESD1LIN (15 V)	$I_R = 1\text{ mA}$	-	-	225	Ω
	PESD1LIN (24 V)	$I_R = 1\text{ mA}$	-	-	300	Ω

[1] Non-repetitive current pulse 8/20 μs exponentially decaying waveform; see [Figure 1](#).

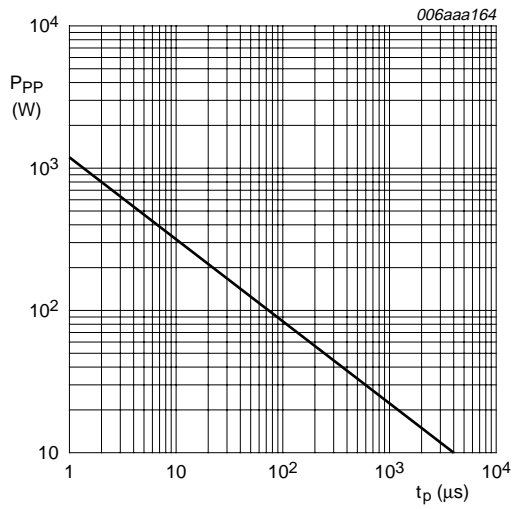

$T_{amb} = 25\text{ }^\circ\text{C}$.

$t_p = 8/20\text{ }\mu\text{s}$ exponentially decaying waveform; see [Figure 1](#).

Fig 3. Peak pulse power dissipation as a function of pulse time; typical values.

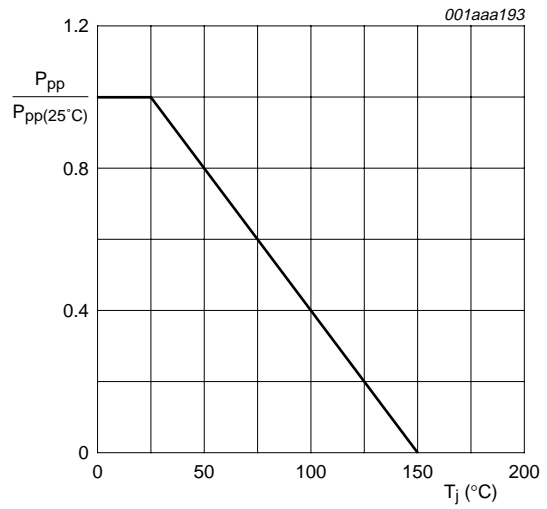

Fig 4. Relative variation of peak pulse power as a function of junction temperature; typical values.

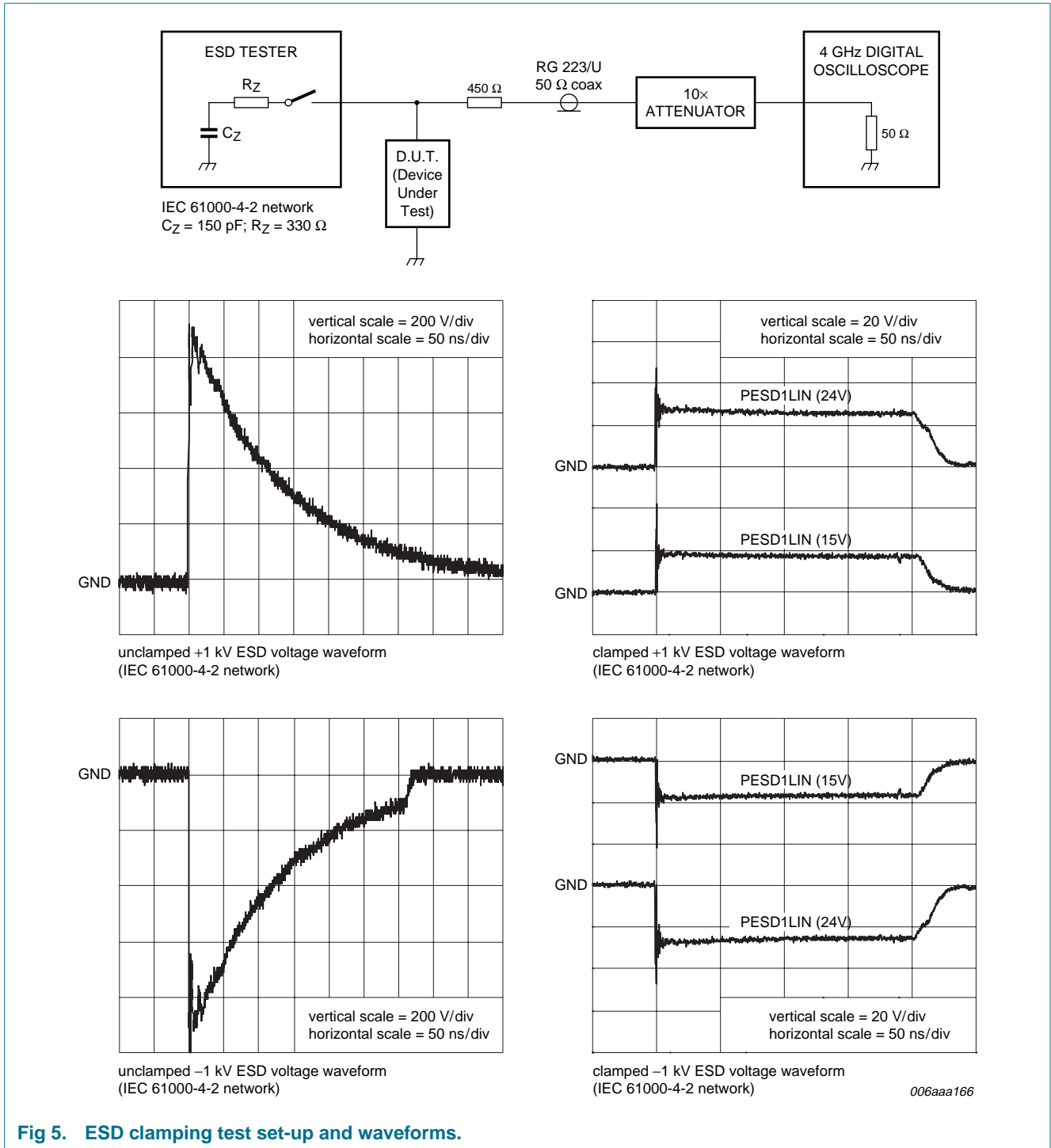

Fig 5. ESD clamping test set-up and waveforms.

7. Application information

The PESD1LIN is designed for protection of one LIN bus signal line from the damage caused by ElectroStatic Discharge (ESD) and surge pulses. The PESD1LIN provides a surge capability of up to 160 W per line for a 8/20 μ s waveform.

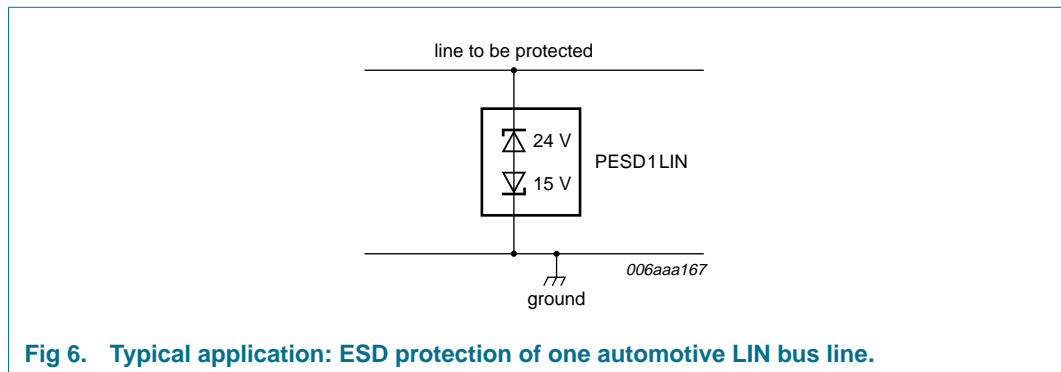

Fig 6. Typical application: ESD protection of one automotive LIN bus line.

Circuit board layout and protection device placement

Circuit board layout is critical for the suppression of ESD, Electrical Fast Transient (EFT) and surge transients. The following guidelines are recommended:

1. Place the protection device as close to the input terminal or connector as possible.
2. The path length between the protection device and the protected line should be minimized.
3. Keep parallel signal paths to a minimum.
4. Avoid running protection conductors in parallel with unprotected conductor.
5. Minimize all printed-circuit board conductive loops including power and ground loops.
6. Minimize the length of the transient return path to ground.
7. Avoid using shared transient return paths to a common ground point.
8. Ground planes should be used whenever possible. For multilayer printed-circuit boards, use ground vias.

8. Package outline

Plastic surface mounted package; 2 leads

SOD323

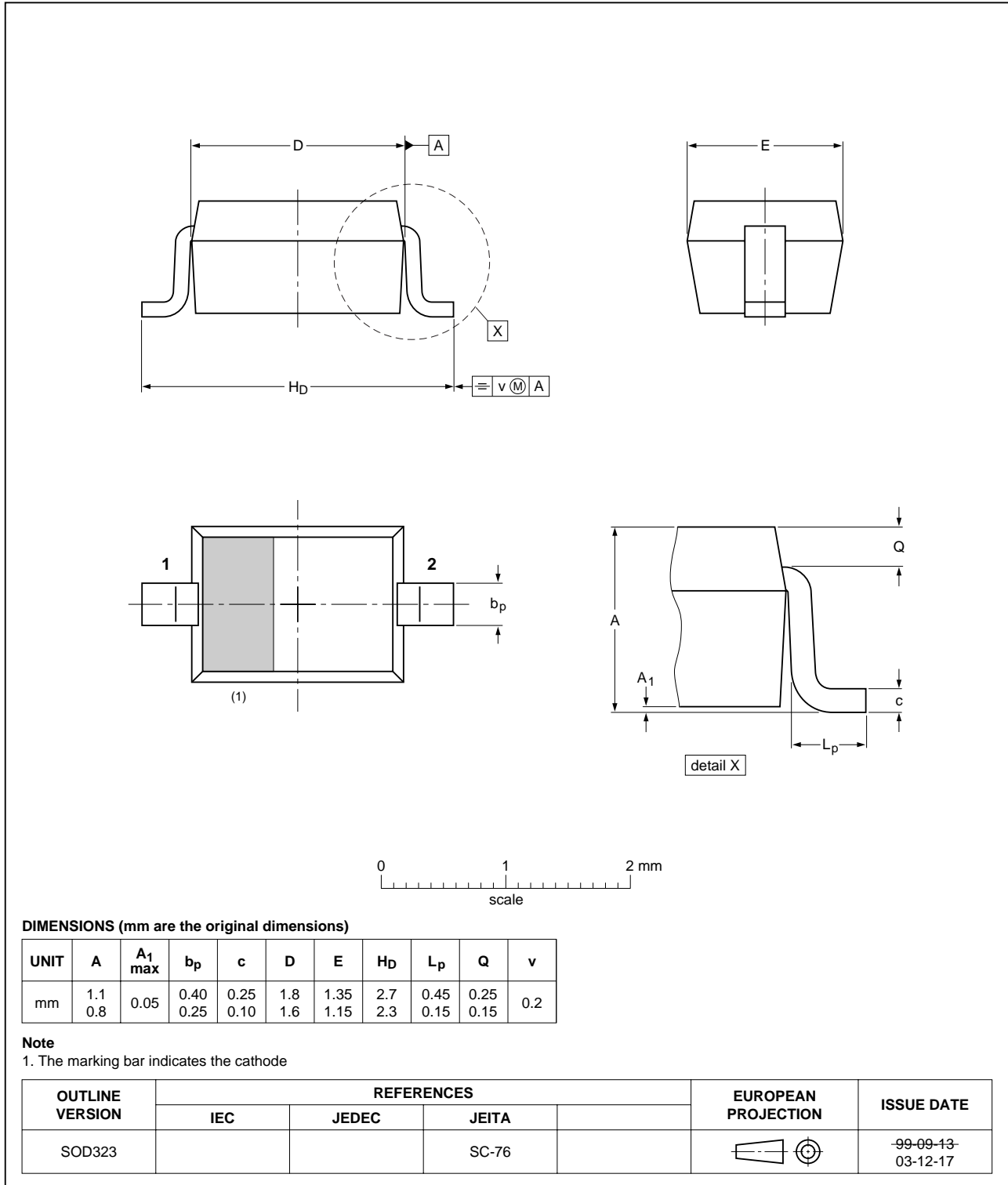

Fig 7. Package outline SOD323 (SC-76).

9. Packing information

Table 9: Packing methods

The indicated -xxx are the last three digits of the 12NC ordering code. [\[1\]](#)

Type number	Package	Description	Packing quantity	
			3000	10000
PESD1LIN	SOD323	4 mm pitch, 8 mm tape and reel	-115	-135

[1] For further information and the availability of packing methods, see [Section 14](#).



10. Revision history

Table 10: Revision history

Document ID	Release date	Data sheet status	Change notice	Doc. number	Supersedes
PESD1LIN_1	20041026	Product data sheet	-	9397 750 14032	-

11. Data sheet status

Level	Data sheet status ^[1]	Product status ^[2] ^[3]	Definition
I	Objective data	Development	This data sheet contains data from the objective specification for product development. Philips Semiconductors reserves the right to change the specification in any manner without notice.
II	Preliminary data	Qualification	This data sheet contains data from the preliminary specification. Supplementary data will be published at a later date. Philips Semiconductors reserves the right to change the specification without notice, in order to improve the design and supply the best possible product.
III	Product data	Production	This data sheet contains data from the product specification. Philips Semiconductors reserves the right to make changes at any time in order to improve the design, manufacturing and supply. Relevant changes will be communicated via a Customer Product/Process Change Notification (CPCN).

[1] Please consult the most recently issued data sheet before initiating or completing a design.

[2] The product status of the device(s) described in this data sheet may have changed since this data sheet was published. The latest information is available on the Internet at URL <http://www.semiconductors.philips.com>.

[3] For data sheets describing multiple type numbers, the highest-level product status determines the data sheet status.

12. Definitions

Short-form specification — The data in a short-form specification is extracted from a full data sheet with the same type number and title. For detailed information see the relevant data sheet or data handbook.

Limiting values definition — Limiting values given are in accordance with the Absolute Maximum Rating System (IEC 60134). Stress above one or more of the limiting values may cause permanent damage to the device. These are stress ratings only and operation of the device at these or at any other conditions above those given in the Characteristics sections of the specification is not implied. Exposure to limiting values for extended periods may affect device reliability.

Application information — Applications that are described herein for any of these products are for illustrative purposes only. Philips Semiconductors make no representation or warranty that such applications will be suitable for the specified use without further testing or modification.

13. Disclaimers

Life support — These products are not designed for use in life support appliances, devices, or systems where malfunction of these products can reasonably be expected to result in personal injury. Philips Semiconductors customers using or selling these products for use in such applications do so at their own risk and agree to fully indemnify Philips Semiconductors for any damages resulting from such application.

Right to make changes — Philips Semiconductors reserves the right to make changes in the products - including circuits, standard cells, and/or software - described or contained herein in order to improve design and/or performance. When the product is in full production (status 'Production'), relevant changes will be communicated via a Customer Product/Process Change Notification (CPCN). Philips Semiconductors assumes no responsibility or liability for the use of any of these products, conveys no license or title under any patent, copyright, or mask work right to these products, and makes no representations or warranties that these products are free from patent, copyright, or mask work right infringement, unless otherwise specified.

14. Contact information

For additional information, please visit: <http://www.semiconductors.philips.com>

For sales office addresses, send an email to: sales.addresses@www.semiconductors.philips.com

15. Contents

1	Product profile	1
1.1	General description	1
1.2	Features	1
1.3	Applications	1
1.4	Quick reference data	1
2	Pinning information	2
3	Ordering information	2
4	Marking	2
5	Limiting values	2
6	Characteristics	4
7	Application information	7
8	Package outline	8
9	Packing information	9
10	Revision history	10
11	Data sheet status	11
12	Definitions	11
13	Disclaimers	11
14	Contact information	11



© Koninklijke Philips Electronics N.V. 2004

All rights are reserved. Reproduction in whole or in part is prohibited without the prior written consent of the copyright owner. The information presented in this document does not form part of any quotation or contract, is believed to be accurate and reliable and may be changed without notice. No liability will be accepted by the publisher for any consequence of its use. Publication thereof does not convey nor imply any license under patent- or other industrial or intellectual property rights.

Date of release: 26 October 2004
Document number: 9397 750 14032

Published in The Netherlands