

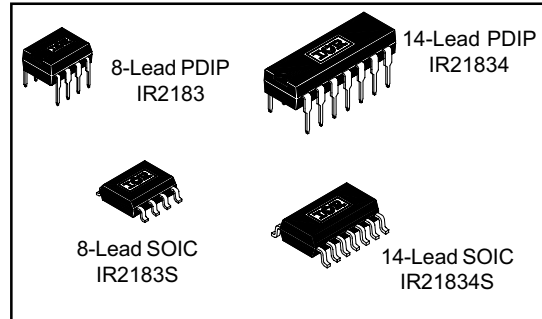
IR2183(4)(S) & (PbF)

HALF-BRIDGE DRIVER

Features

- Floating channel designed for bootstrap operation
Fully operational to +600V
Tolerant to negative transient voltage
dV/dt immune
- Gate drive supply range from 10 to 20V
- Undervoltage lockout for both channels
- 3.3V and 5V input logic compatible
- Matched propagation delay for both channels
- Logic and power ground +/- 5V offset.
- Lower di/dt gate driver for better noise immunity
- Output source/sink current capability 1.4A/1.8A
- Also available LEAD-FREE (PbF)

Packages



Description

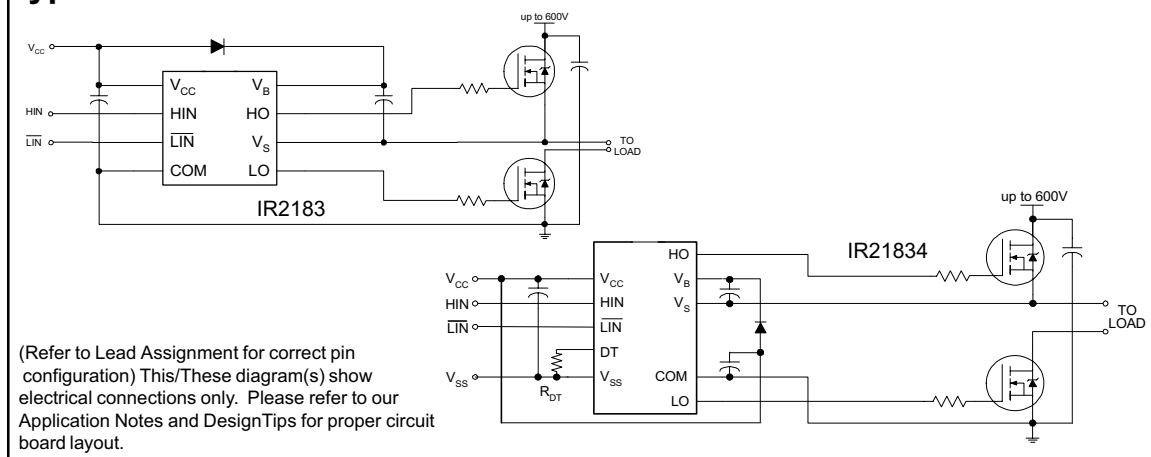
The IR2183(4)(S) are high voltage, high speed power MOSFET and IGBT drivers with dependent high and low side referenced output channels. Proprietary HVIC and latch immune CMOS technologies enable ruggedized monolithic construction. The logic input is compatible with standard CMOS or LSTTL output, down to 3.3V

logic. The output drivers feature a high pulse current buffer stage designed for minimum driver cross-conduction. The floating channel can be used to drive an N-channel power MOSFET or IGBT in the high side configuration which operates up to 600 volts.

IR2181/IR2183/IR2184 Feature Comparison

| Part | Input logic | Cross-conduction prevention logic | Dead-Time | Ground Pins | Ton/Toff |
|-------|-------------|-----------------------------------|--------------------------------------|-------------|------------|
| 2181 | HIN/LIN | no | none | COM | 180/220 ns |
| 21814 | | | | VSS/COM | |
| 2183 | HIN/LIN | yes | Internal 500ns Program 0.4 ~ 5 us | COM | 180/220 ns |
| 21834 | | | | VSS/COM | |
| 2184 | IN/SD | yes | Internal 500ns Program 0.4 ~ 5 us | COM | 680/270 ns |
| 21844 | | | | VSS/COM | |

Typical Connection



IR2183(4)(S) & (PbF)

Absolute Maximum Ratings

Absolute maximum ratings indicate sustained limits beyond which damage to the device may occur. All voltage parameters are absolute voltages referenced to COM. The thermal resistance and power dissipation ratings are measured under board mounted and still air conditions.

| Symbol | Definition | Min. | Max. | Units | |
|---------------------|--|-----------------------|-----------------------|-------|------|
| V _B | High side floating absolute voltage | -0.3 | 625 | V | |
| V _S | High side floating supply offset voltage | V _B - 25 | V _B + 0.3 | | |
| V _{HO} | High side floating output voltage | V _S - 0.3 | V _B + 0.3 | | |
| V _{CC} | Low side and logic fixed supply voltage | -0.3 | 25 | | |
| V _{LO} | Low side output voltage | -0.3 | V _{CC} + 0.3 | | |
| DT | Programmable dead-time pin voltage (IR21834 only) | V _{SS} - 0.3 | V _{CC} + 0.3 | | |
| V _{IN} | Logic input voltage (HIN & $\overline{\text{LIN}}$) | V _{SS} - 0.3 | V _{SS} + 10 | | |
| V _{SS} | Logic ground (IR21834 only) | V _{CC} - 25 | V _{CC} + 0.3 | | |
| dV _S /dt | Allowable offset supply voltage transient | — | 50 | V/ns | |
| P _D | Package power dissipation @ T _A ≤ +25°C | (8-lead PDIP) | — | 1.0 | W |
| | | (8-lead SOIC) | — | 0.625 | |
| | | (14-lead PDIP) | — | 1.6 | |
| | | (14-lead SOIC) | — | 1.0 | |
| R _{thJA} | Thermal resistance, junction to ambient | (8-lead PDIP) | — | 125 | °C/W |
| | | (8-lead SOIC) | — | 200 | |
| | | (14-lead PDIP) | — | 75 | |
| | | (14-lead SOIC) | — | 120 | |
| T _J | Junction temperature | — | 150 | °C | |
| T _S | Storage temperature | -50 | 150 | | |
| T _L | Lead temperature (soldering, 10 seconds) | — | 300 | | |

Recommended Operating Conditions

The Input/Output logic timing diagram is shown in figure 1. For proper operation the device should be used within the recommended conditions. The V_S and V_{SS} offset rating are tested with all supplies biased at 15V differential.

| Symbol | Definition | Min. | Max. | Units |
|-----------------|--|---------------------|---------------------|-------|
| V _B | High side floating supply absolute voltage | V _S + 10 | V _S + 20 | V |
| V _S | High side floating supply offset voltage | Note 1 | 600 | |
| V _{HO} | High side floating output voltage | V _S | V _B | |
| V _{CC} | Low side and logic fixed supply voltage | 10 | 20 | |
| V _{LO} | Low side output voltage | 0 | V _{CC} | |
| V _{IN} | Logic input voltage (HIN & $\overline{\text{LIN}}$) | V _{SS} | V _{SS} + 5 | |
| DT | Programmable dead-time pin voltage (IR21834 only) | V _{SS} | V _{CC} | |
| V _{SS} | Logic ground (IR21834 only) | -5 | 5 | |
| T _A | Ambient temperature | -40 | 125 | °C |

Note 1: Logic operational for V_S of -5 to +600V. Logic state held for V_S of -5V to -V_{BS}. (Please refer to the Design Tip DT97-3 for more details).

Note 2: HIN and $\overline{\text{LIN}}$ pins are internally clamped with a 5.2V zener diode.

Dynamic Electrical Characteristics

$V_{BIAS} (V_{CC}, V_{BS}) = 15V, V_{SS} = COM, C_L = 1000 \text{ pF}, T_A = 25^\circ\text{C}, DT = V_{SS}$ unless otherwise specified.

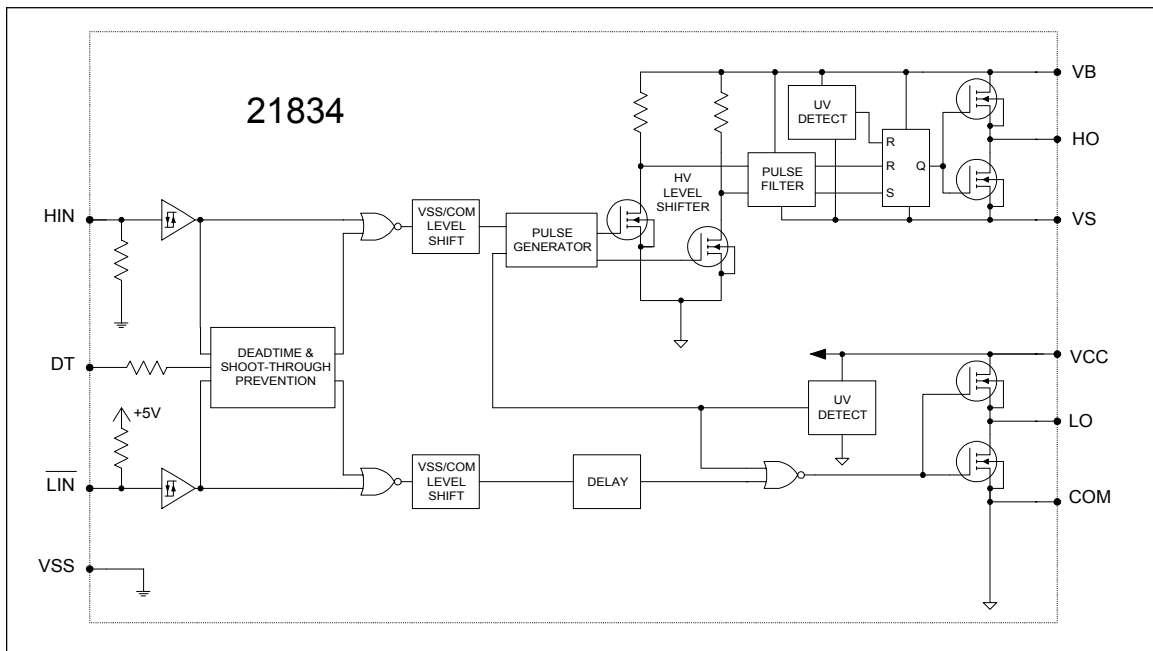
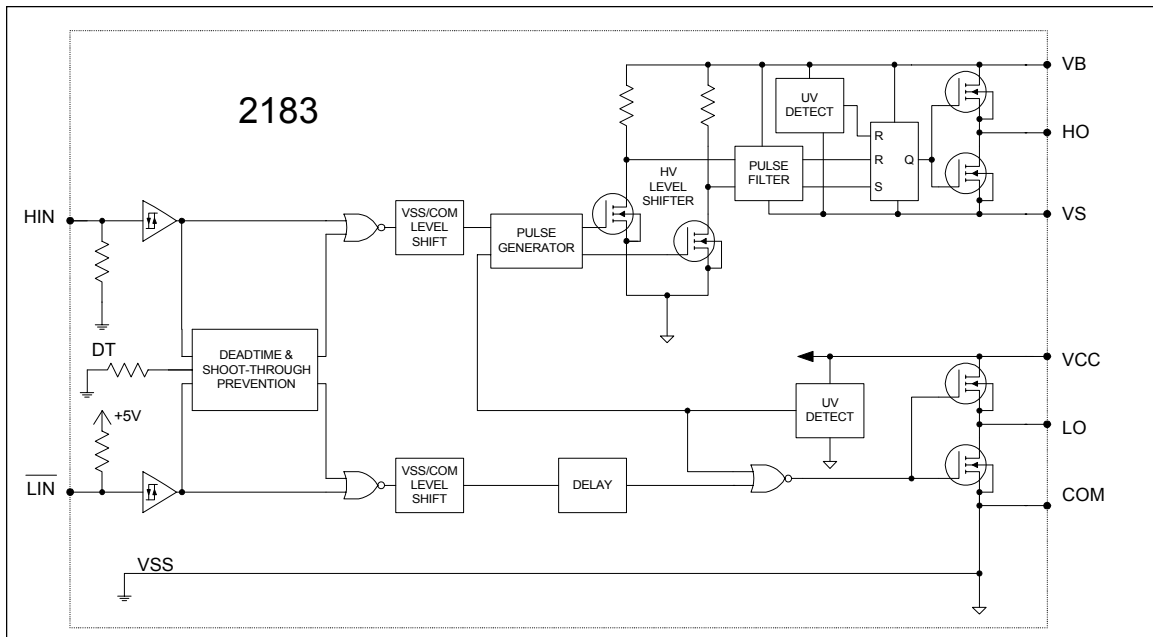
| Symbol | Definition | Min. | Typ. | Max. | Units | Test Conditions |
|-----------|---|------|------|------|----------------------|----------------------|
| t_{on} | Turn-on propagation delay | — | 180 | 270 | nsec | $V_S = 0V$ |
| t_{off} | Turn-off propagation delay | — | 220 | 330 | | $V_S = 0V$ or $600V$ |
| MT | Delay matching $ t_{on} - t_{off} $ | — | 0 | 35 | | |
| t_r | Turn-on rise time | — | 40 | 60 | | $V_S = 0V$ |
| t_f | Turn-off fall time | — | 20 | 35 | | $V_S = 0V$ |
| DT | Deadtime: LO turn-off to HO turn-on (DT _{LO-HO}) & HO turn-off to LO turn-on (DT _{HO-LO}) | 280 | 400 | 520 | | μsec |
| | | 4 | 5 | 6 | RDT = 200k (IR21834) | |
| MDT | Deadtime matching = $ DT_{LO-HO} - DT_{HO-LO} $ | — | 0 | 50 | nsec | RDT = 0 |
| | | — | 0 | 600 | | RDT = 200k (IR21834) |

Static Electrical Characteristics

$V_{BIAS} (V_{CC}, V_{BS}) = 15V, V_{SS} = COM, DT = V_{SS}$ and $T_A = 25^\circ\text{C}$ unless otherwise specified. The V_{IL} , V_{IH} and I_{IN} parameters are referenced to V_{SS}/COM and are applicable to the respective input leads: HIN and LIN. The V_O , I_O and R_{on} parameters are referenced to COM and are applicable to the respective output leads: HO and LO.

| Symbol | Definition | Min. | Typ. | Max. | Units | Test Conditions |
|----------------------------|--|------|------|------|-------|------------------------------------|
| V_{IH} | Logic "1" input voltage for HIN & logic "0" for \overline{LIN} | 2.7 | — | — | V | $V_{CC} = 10V$ to $20V$ |
| V_{IL} | Logic "0" input voltage for HIN & logic "1" for \overline{LIN} | — | — | 0.8 | | $V_{CC} = 10V$ to $20V$ |
| V_{OH} | High level output voltage, $V_{BIAS} - V_O$ | — | — | 1.2 | | $I_O = 0A$ |
| V_{OL} | Low level output voltage, V_O | — | — | 0.1 | | $I_O = 0A$ |
| I_{LK} | Offset supply leakage current | — | — | 50 | μA | $V_B = V_S = 600V$ |
| I_{QBS} | Quiescent V_{BS} supply current | 20 | 60 | 150 | μA | $V_{IN} = 0V$ or $5V$ |
| I_{QCC} | Quiescent V_{CC} supply current | 0.4 | 1.0 | 1.6 | mA | $V_{IN} = 0V$ or $5V$ |
| I_{IN+} | Logic "1" input bias current | — | 5 | 20 | μA | $HIN = 5V, \overline{LIN} = 0V$ |
| I_{IN-} | Logic "0" input bias current | — | 1 | 2 | | $HIN = 0V, \overline{LIN} = 5V$ |
| V_{CCUV+} V_{BSUV+} | V_{CC} and V_{BS} supply undervoltage positive going threshold | 8.0 | 8.9 | 9.8 | V | |
| V_{CCUV-} V_{BSUV-} | V_{CC} and V_{BS} supply undervoltage negative going threshold | 7.4 | 8.2 | 9.0 | | |
| V_{CCUVH} V_{BSUVH} | Hysteresis | 0.3 | 0.7 | — | | |
| I_{O+} | Output high short circuit pulsed current | 1.4 | 1.9 | — | A | $V_O = 0V,$ $PW \leq 10 \mu s$ |
| I_{O-} | Output low short circuit pulsed current | 1.8 | 2.3 | — | | $V_O = 15V,$ $PW \leq 10 \mu s$ |

Functional Block Diagrams



Lead Definitions

| Symbol | Description |
|-----------------|---|
| HIN | Logic input for high side gate driver output (HO), in phase (referenced to COM for IR2183 and VSS for IR21834) |
| LIN | Logic input for low side gate driver output (LO), out of phase (referenced to COM for IR2183 and VSS for IR21834) |
| DT | Programmable dead-time lead, referenced to VSS. (IR21834 only) |
| VSS | Logic Ground (21834 only) |
| V _B | High side floating supply |
| HO | High side gate driver output |
| V _S | High side floating supply return |
| V _{CC} | Low side and logic fixed supply |
| LO | Low side gate driver output |
| COM | Low side return |

Lead Assignments

| | |
|---------------------|---------------------|
| <p>8-Lead PDIP</p> | <p>8-Lead SOIC</p> |
| IR2183 | IR2183S |
| <p>14-Lead PDIP</p> | <p>14-Lead SOIC</p> |
| IR21834 | IR21834S |

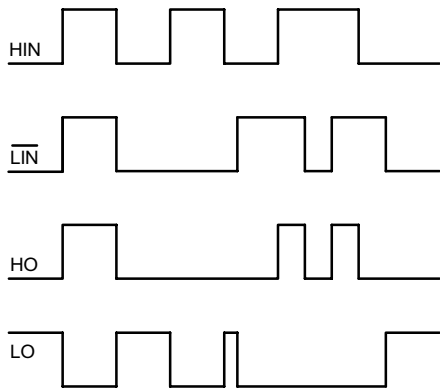


Figure 1. Input/Output Timing Diagram

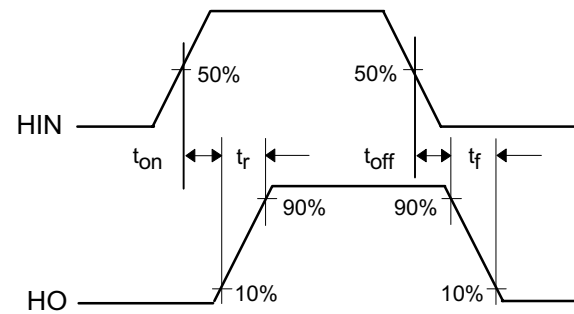
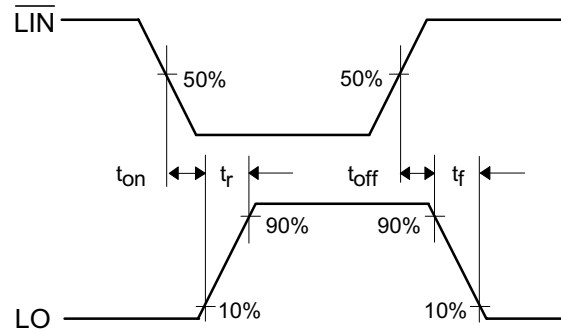


Figure 2. Switching Time Waveform Definitions

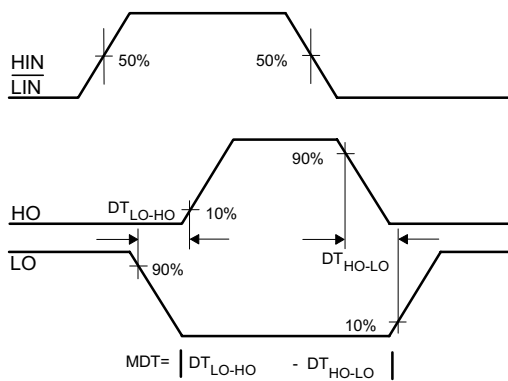


Figure 3. Deadtime Waveform Definitions

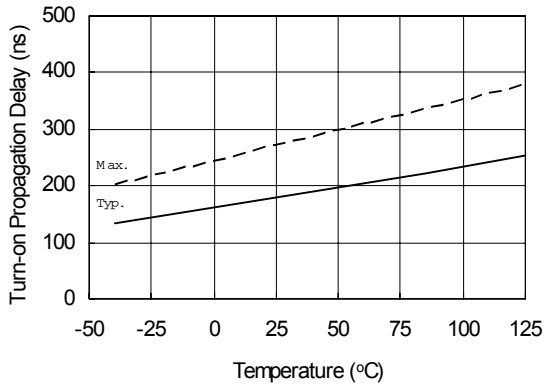


Figure 4A. Turn-on Propagation Delay vs. Temperature

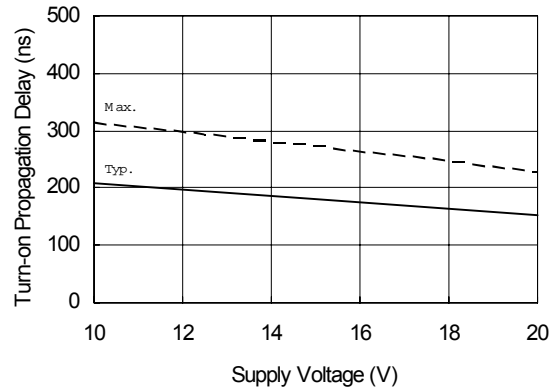


Figure 4B. Turn-on Propagation Delay vs. Supply Voltage

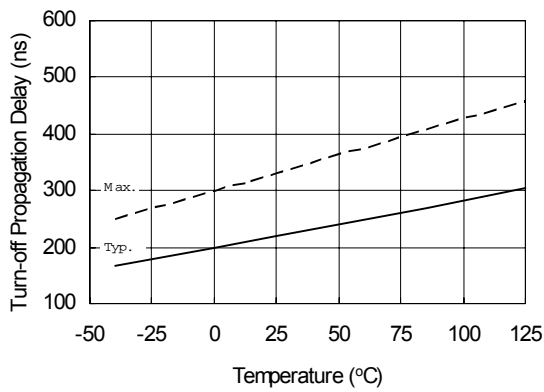


Figure 5A. Turn-off Propagation Delay vs. Temperature

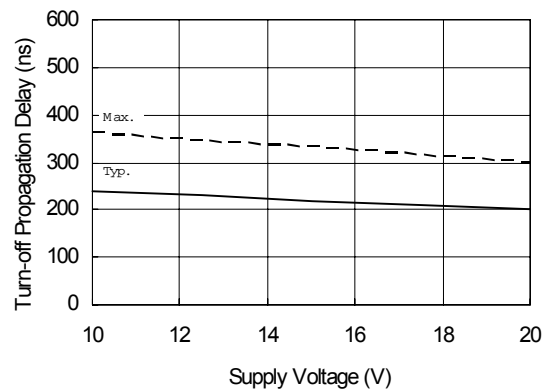


Figure 5B. Turn-off Propagation Delay vs. Supply Voltage

IR2183(4)(S) & (PbF)

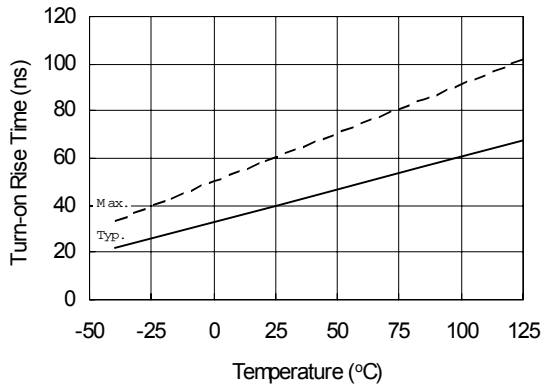


Figure 6A. Turn-on Rise Time vs. Temperature

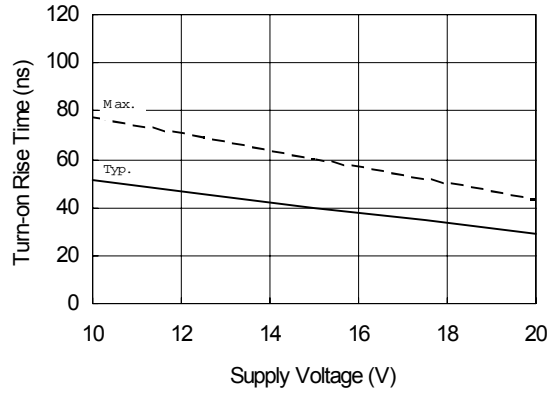


Figure 6B. Turn-on Rise Time vs. Supply Voltage

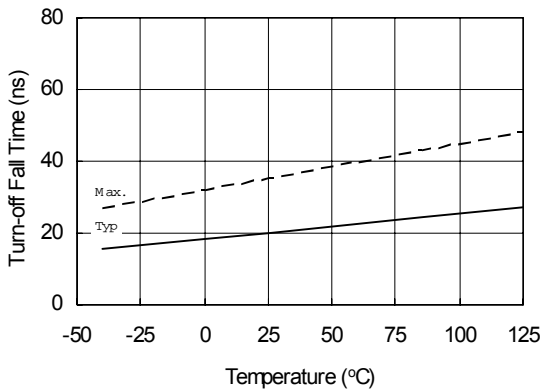


Figure 7A. Turn-off Fall Time vs. Temperature

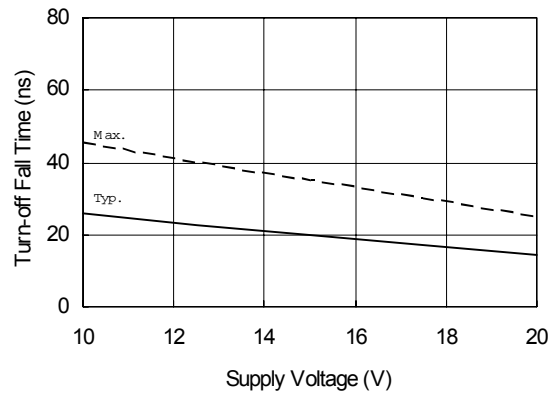


Figure 7B. Turn-off Fall Time vs. Supply Voltage

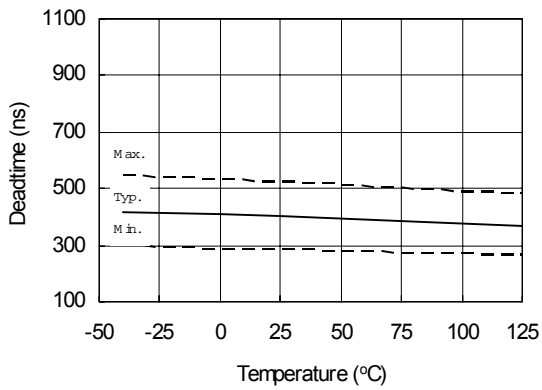


Figure 8A. Deadtime vs. Temperature

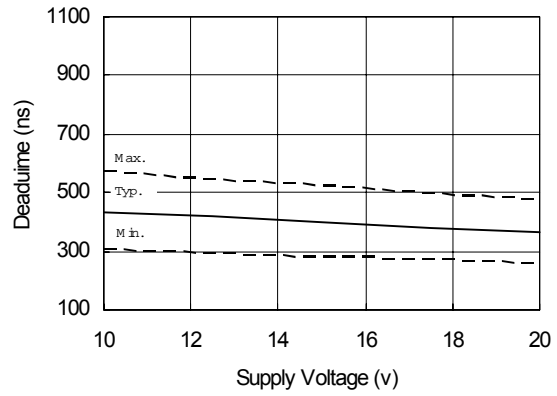


Figure 8B. Deadtime vs. Supply Voltage

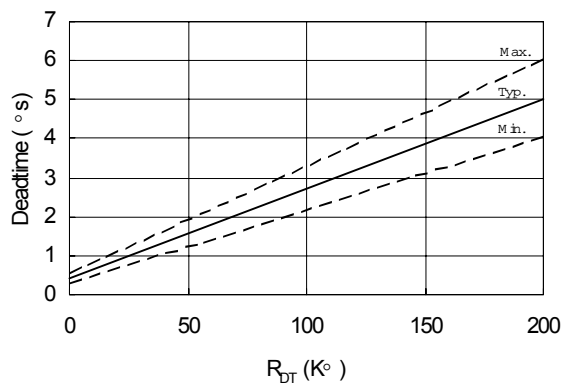


Figure 8C. Deadtime vs. R_{DT}

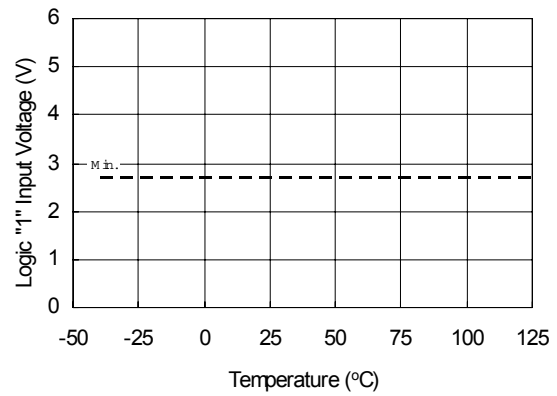


Figure 9A. Logic "1" Input Voltage vs. Temperature

IR2183(4)(S) & (PbF)

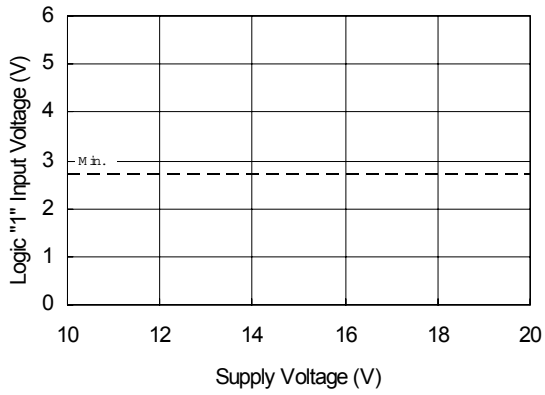


Figure 9B. Logic "1" Input Voltage vs. Supply Voltage

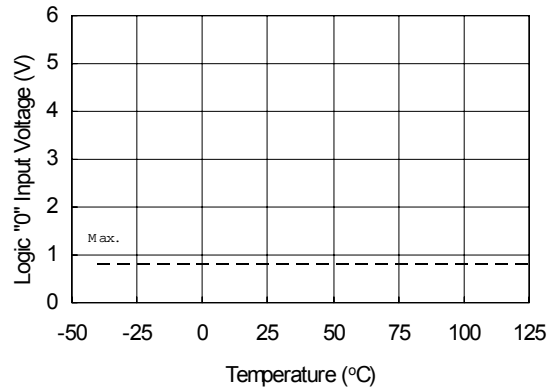


Figure 10A. Logic "0" Input Voltage vs. Temperature

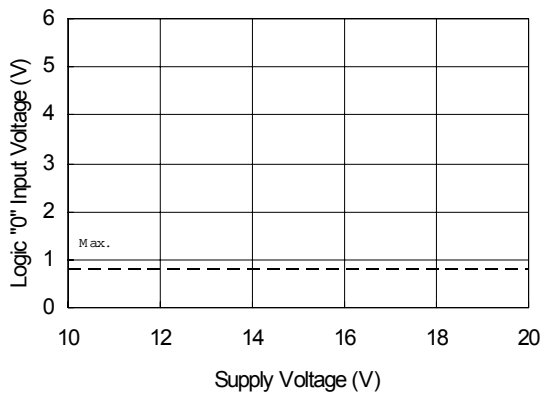


Figure 10B. Logic "0" Input Voltage vs. Supply Voltage

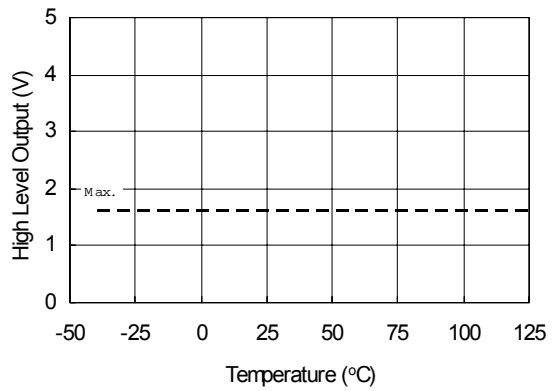


Figure 11A. High Level Output vs. Temperature

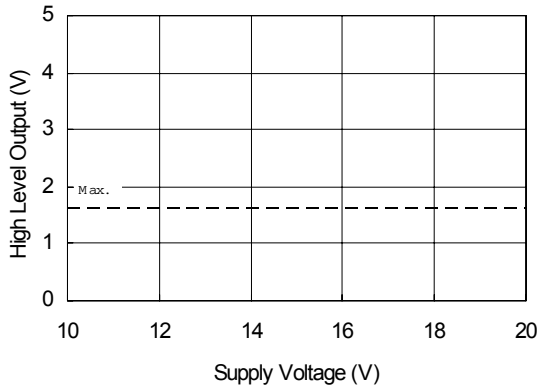


Figure 11B. High Level Output vs. Supply Voltage

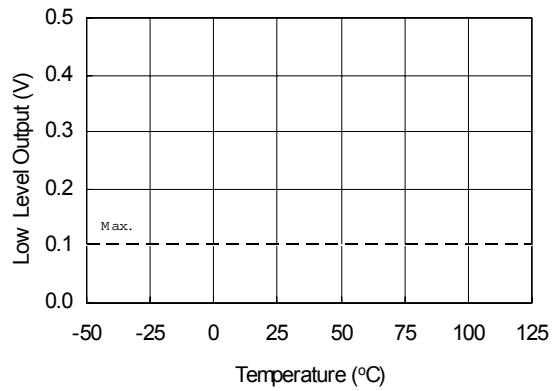


Figure 12A. Low Level Output vs. Temperature

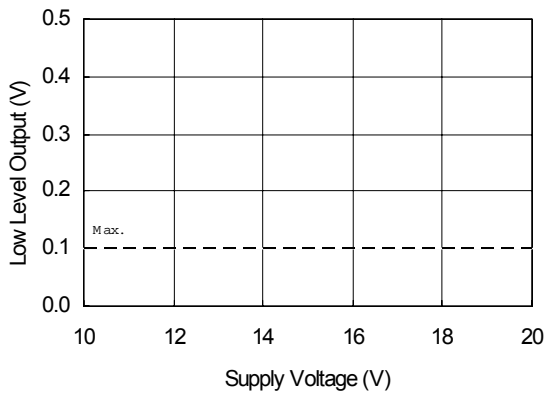


Figure 12B. Low Level Output vs. Supply Voltage

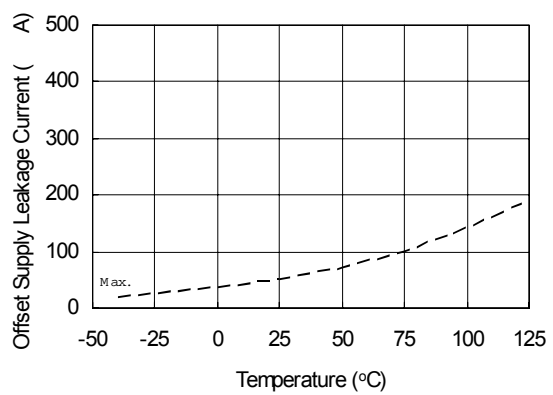


Figure 13A. Offset Supply Leakage Current vs. Temperature

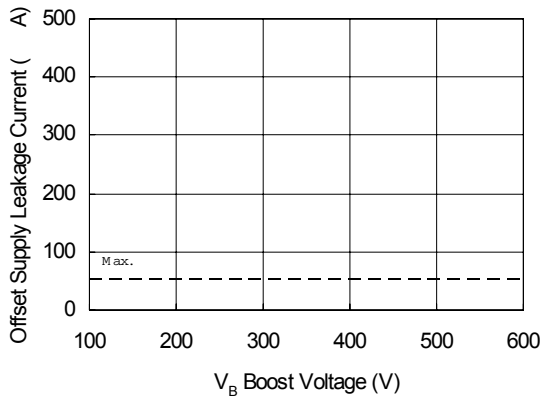


Figure 13B. Offset Supply Leakage Current vs. V_B Boost Voltage

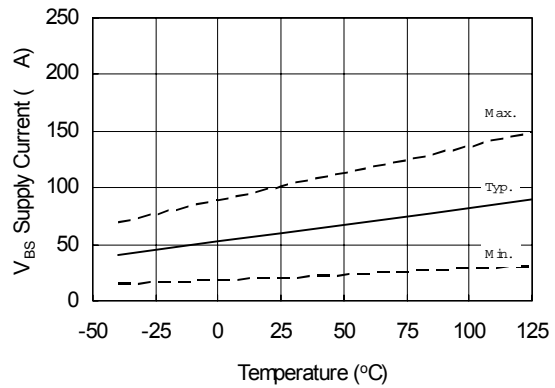


Figure 14A. V_{BS} Supply Current vs. Temperature

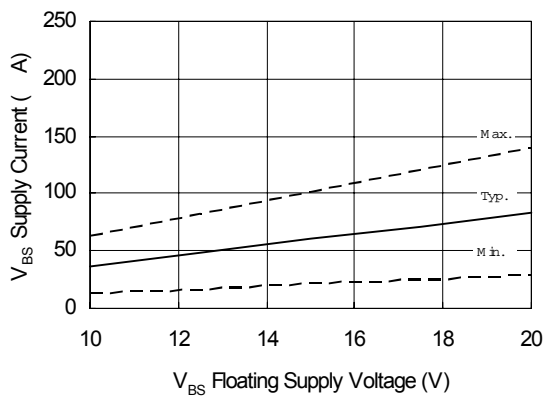


Figure 14B. V_{BS} Supply Current vs. V_{BS} Floating Supply Voltage

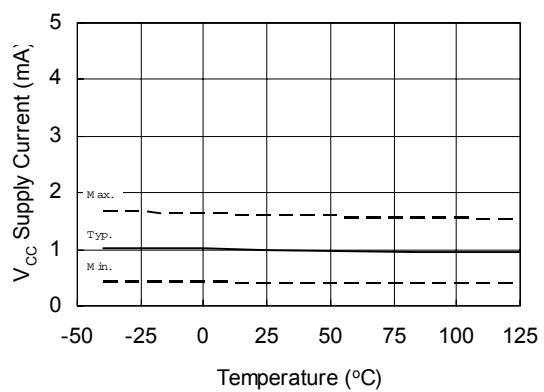


Figure 15A. V_{CC} Supply Current vs. Temperature

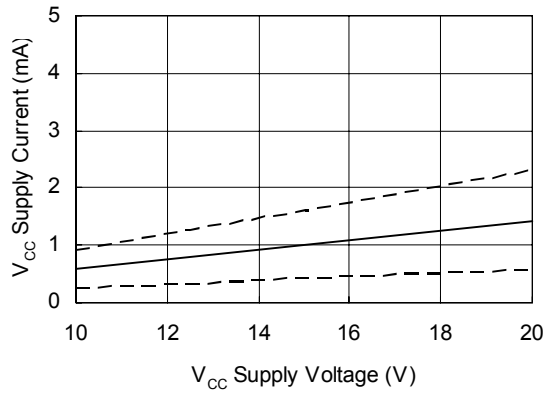


Figure 15B. V_{CC} Supply Current vs. V_{CC} Supply Voltage

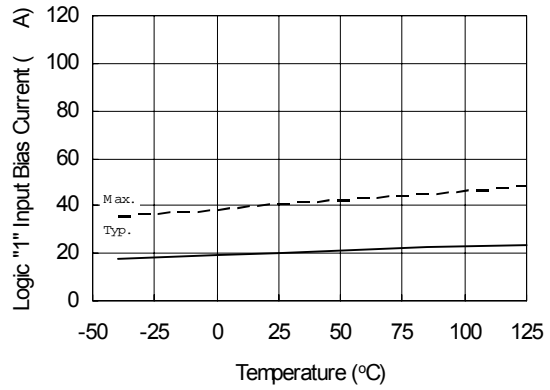


Figure 16A. Logic "1" Input Bias Current vs. Temperature

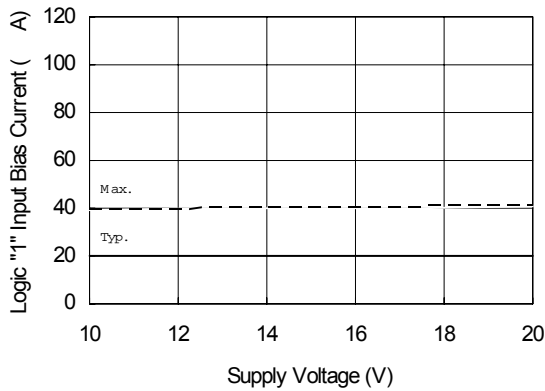


Figure 16B. Logic "1" Input Bias Current vs. Supply Voltage

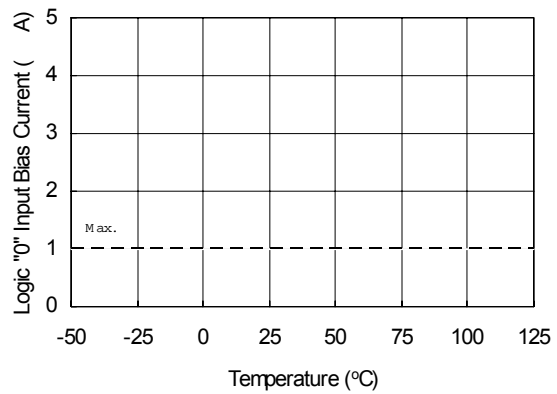


Figure 17A. Logic "0" Input Bias Current vs. Temperature

IR2183(4)(S) & (PbF)

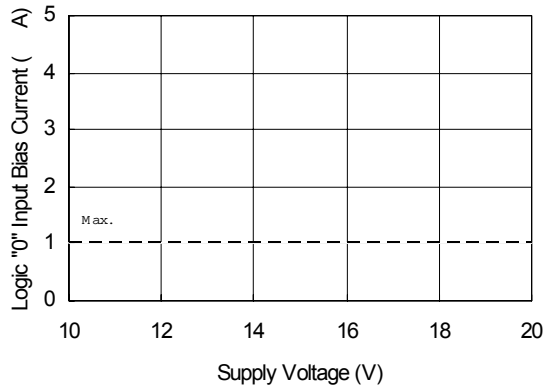


Figure 17B. Logic "0" Input Bias Current vs. Supply Voltage

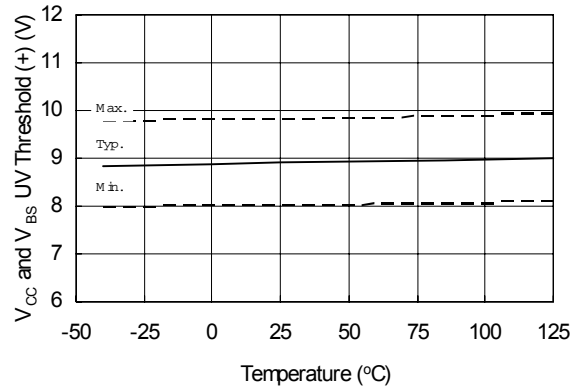


Figure 18. V_{CC} and V_{BS} Undervoltage Threshold (+) vs. Temperature

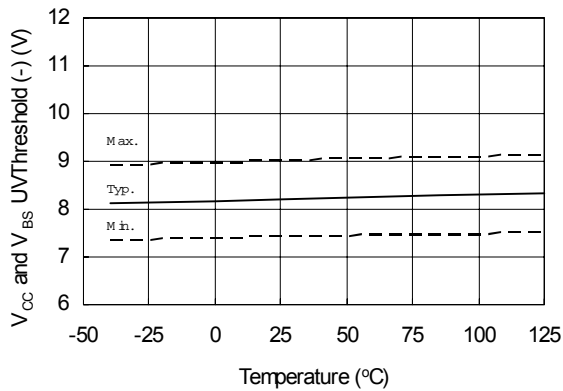


Figure 19. V_{CC} and V_{BS} Undervoltage Threshold (-) vs. Temperature

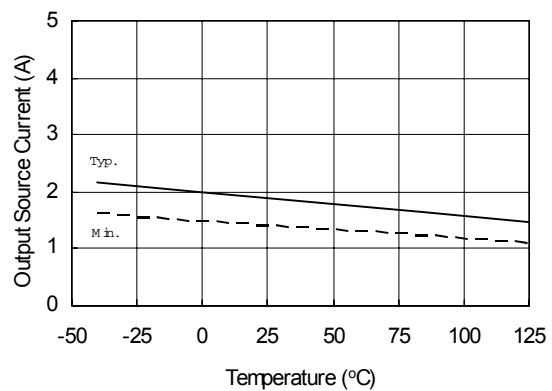


Figure 20A. Output Source Current vs. Temperature

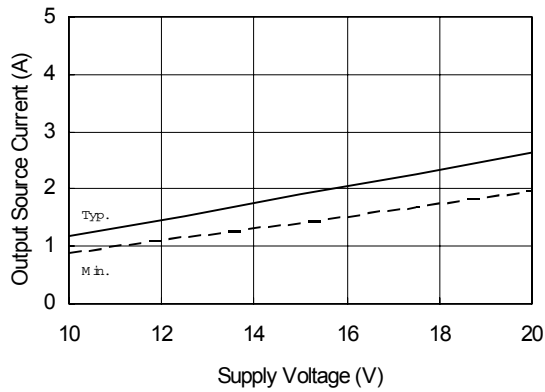


Figure 20B. Output Source Current vs. Supply Voltage

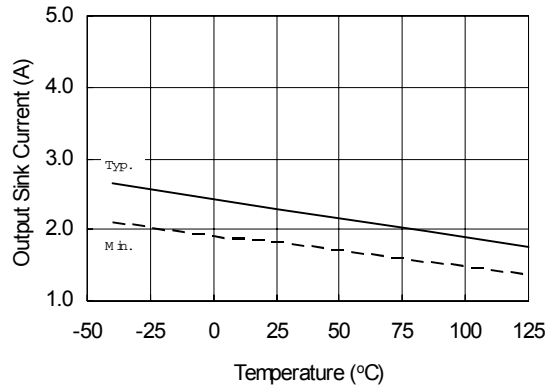


Figure 21A. Output Sink Current vs. Temperature

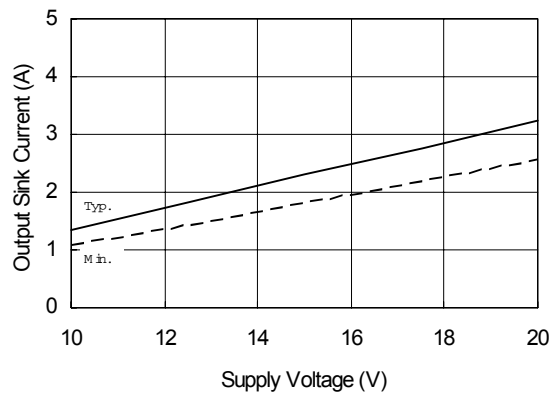
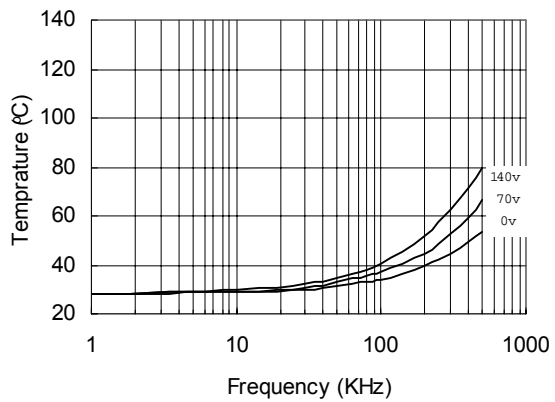
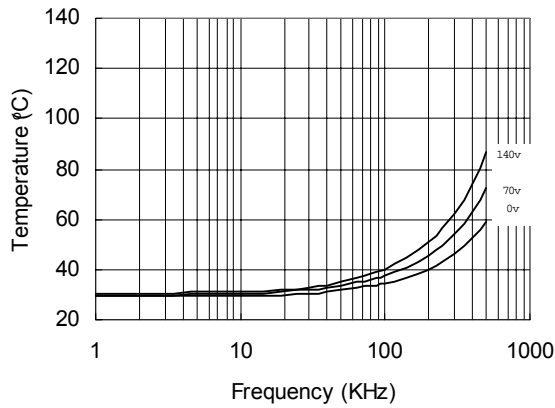


Figure 21B. Output Sink Current vs. Supply Voltage

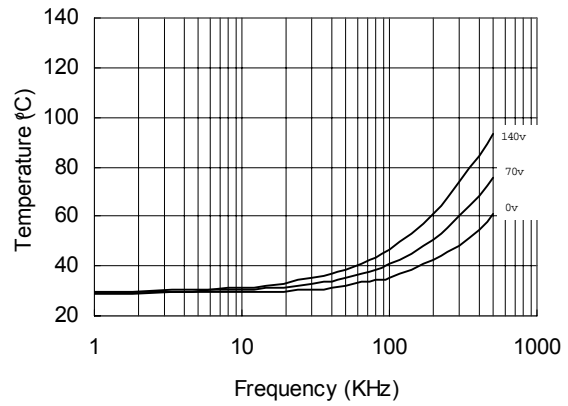


**Figure 22. IR2183 vs. Frequency (IRFBC20),
 $R_{gate}=33\Omega$, $V_{CC}=15V$**

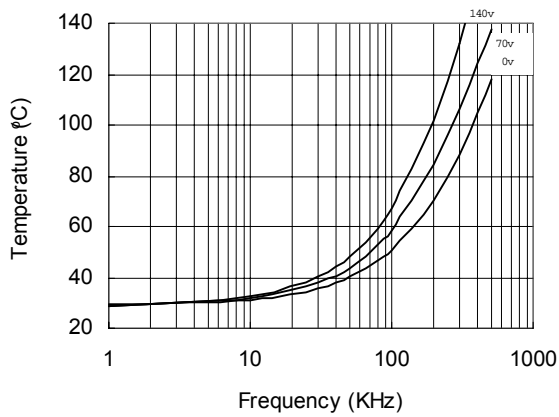
IR2183(4)(S) & (PbF)



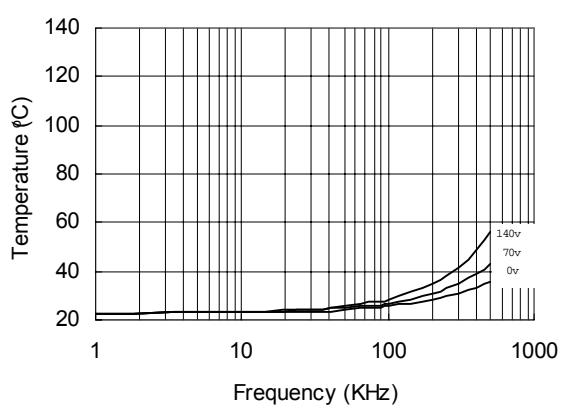
**Figure 23. IR2183 vs. Frequency (IRFBC30),
 $R_{gate}=22\Omega$, $V_{CC}=15V$**



**Figure 24. IR2183 vs. Frequency (IRFBC40),
 $R_{gate}=15\Omega$, $V_{CC}=15V$**

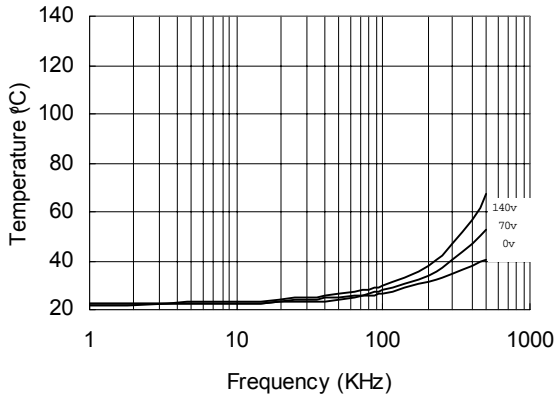


**Figure 25. IR2183 vs. Frequency (IRFPE50),
 $R_{gate}=10\Omega$, $V_{CC}=15V$**

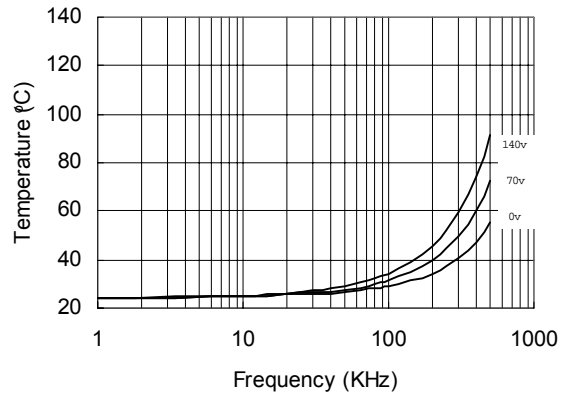


**Figure 26. IR21834 vs. Frequency (IRFBC20),
 $R_{gate}=33\Omega$, $V_{CC}=15V$**

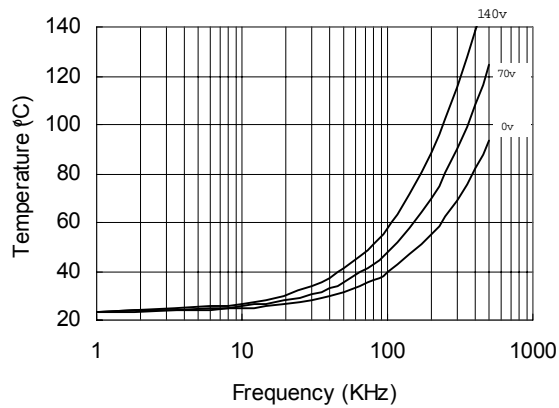
IR2183(4)(S) & (PbF)



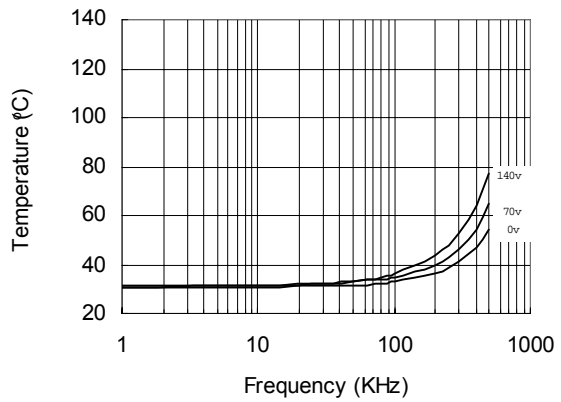
**Figure 27. IR21834 vs. Frequency (IRFBC30),
 $R_{gate}=22\Omega, V_{CC}=15V$**



**Figure 28. IR21834 vs. Frequency (IRFBC40),
 $R_{gate}=15\Omega, V_{CC}=15V$**



**Figure 29. IR21834 vs. Frequency (IRFPE50),
 $R_{gate}=10\Omega, V_{CC}=15V$**



**Figure 30. IR2183s vs. Frequency (IRFBC20),
 $R_{gate}=33\Omega, V_{CC}=15V$**

IR2183(4)(S) & (PbF)

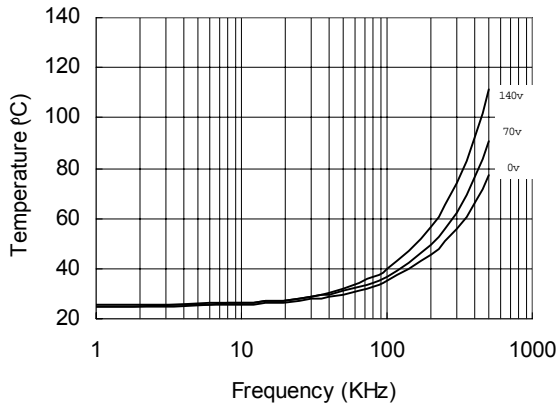


Figure 31. IR2183s vs. Frequency (IRFBC30),
 $R_{gate}=22\Omega, V_{CC}=15V$

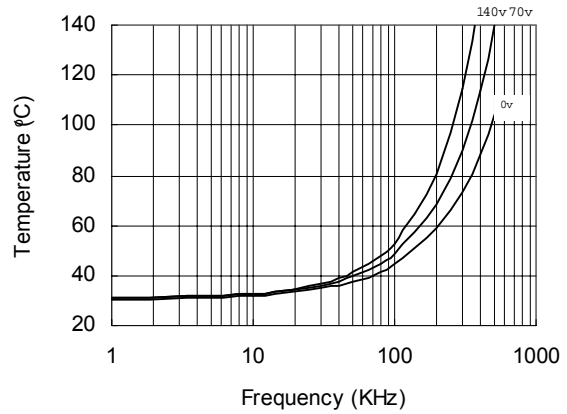


Figure 32. IR2183s vs. Frequency (IRFBC40),
 $R_{gate}=15\Omega, V_{CC}=15V$

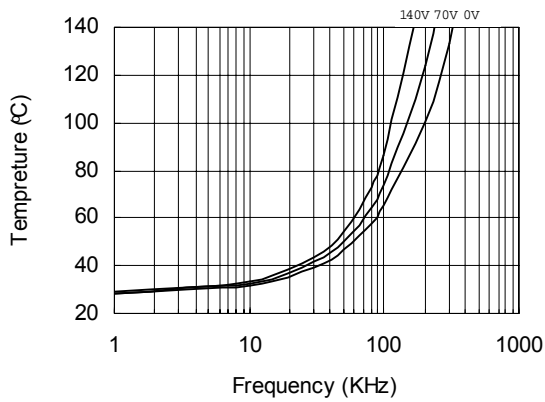


Figure 33. IR2183s vs. Frequency (IRFPE50),
 $R_{gate}=10\Omega, V_{CC}=15V$

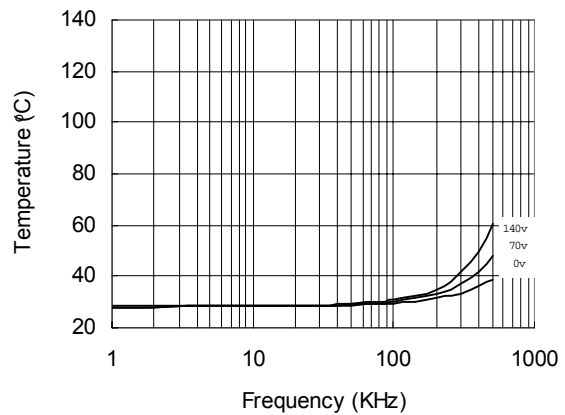
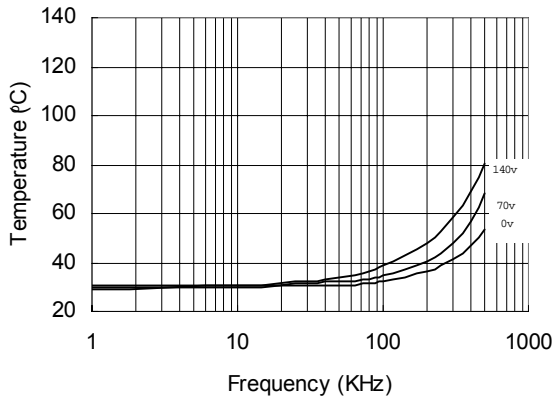
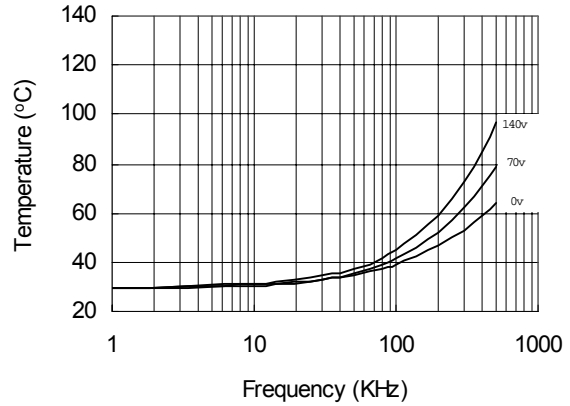


Figure 34. IR21834s vs. Frequency (IRFBC20),
 $R_{gate}=33\Omega, V_{CC}=15V$

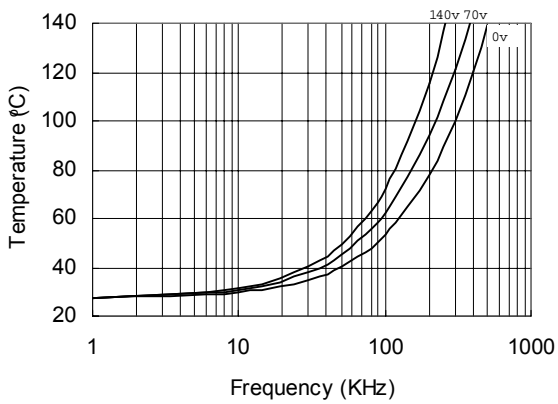
IR2183(4)(S) & (PbF)



**Figure 35. IR21834s vs. Frequency (IRFBC30),
 $R_{gate}=22\Omega, V_{CC}=15V$**



**Figure 36. IR21834s vs. Frequency (IRFBC40),
 $R_{gate}=15\Omega, V_{CC}=15V$**

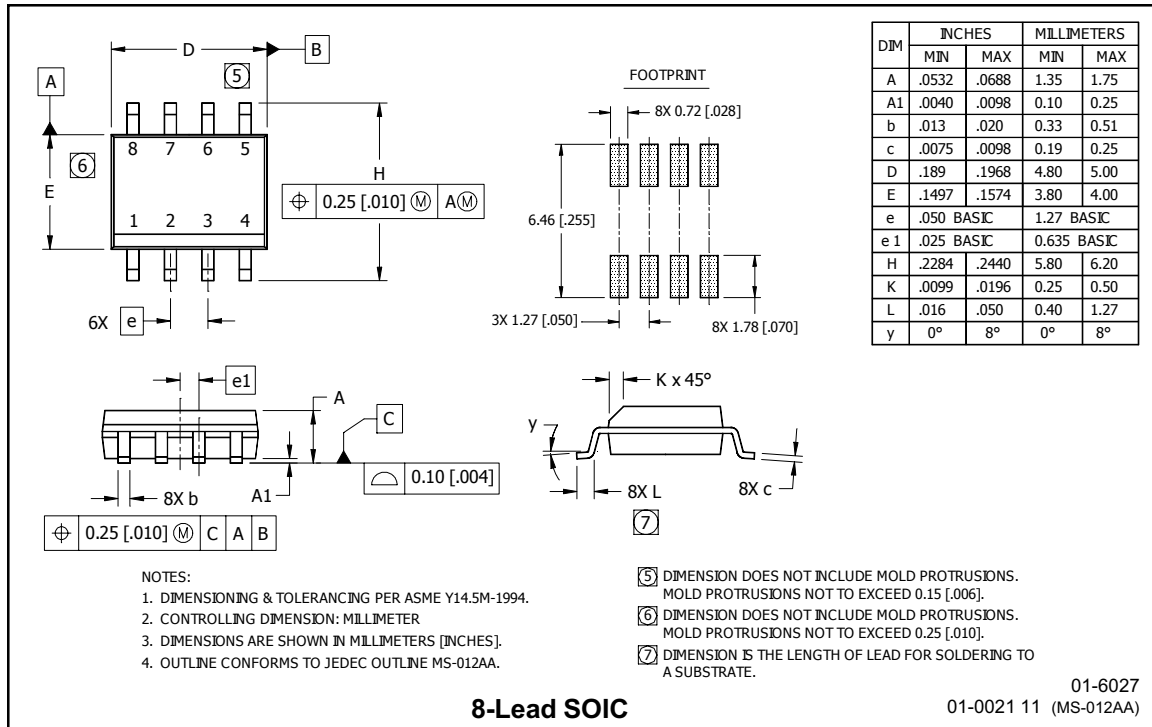
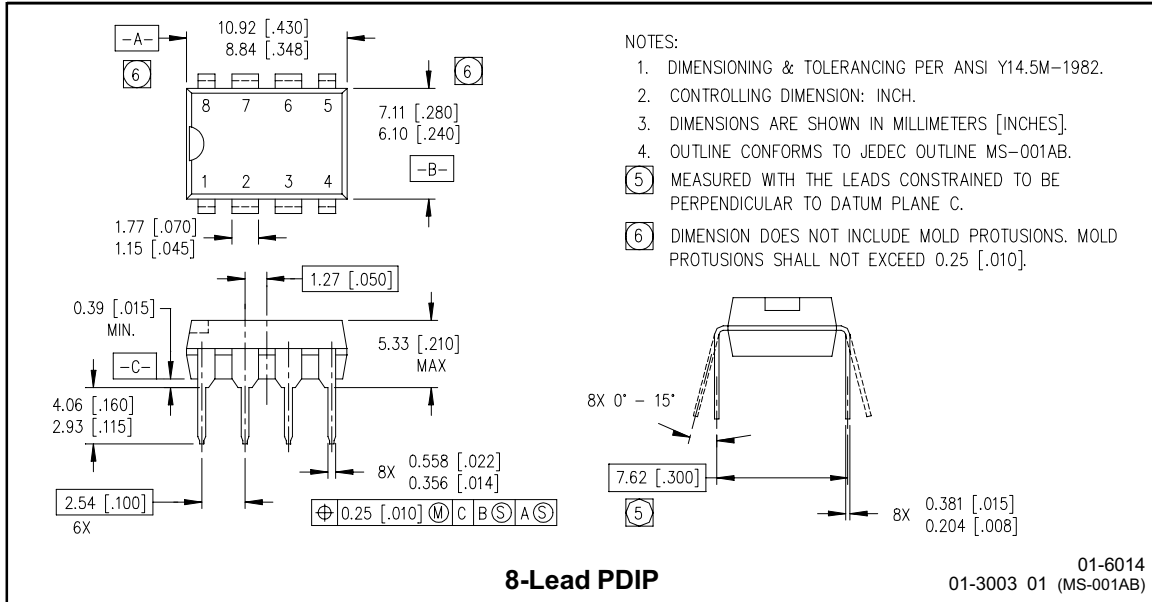


**Figure 37. IR21834s vs. Frequency (IRFPE50),
 $R_{gate}=10\Omega, V_{CC}=15V$**

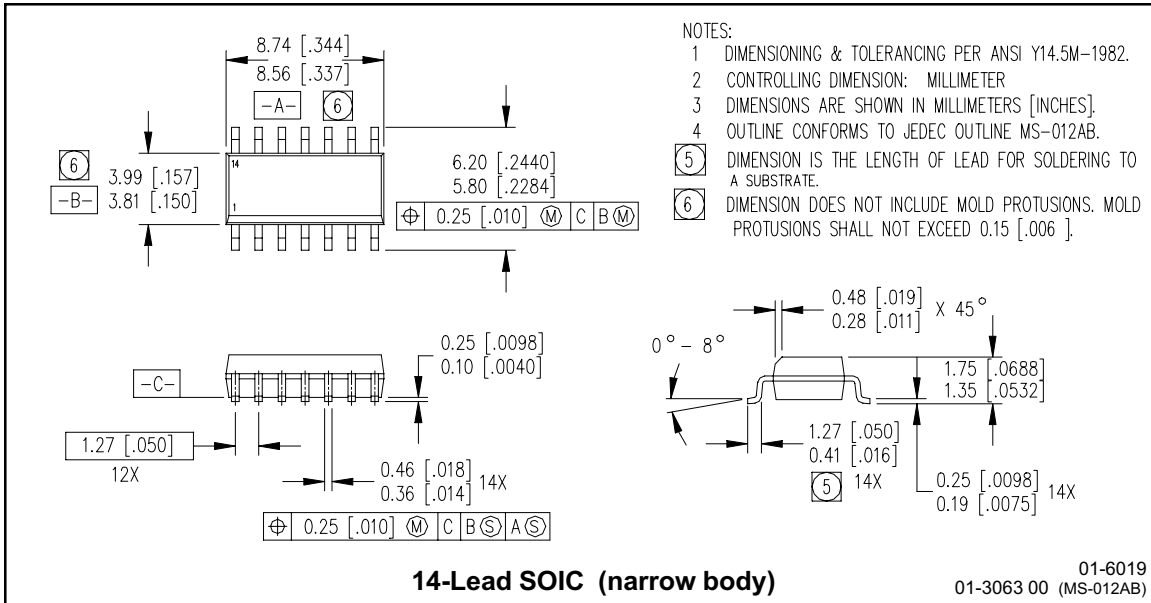
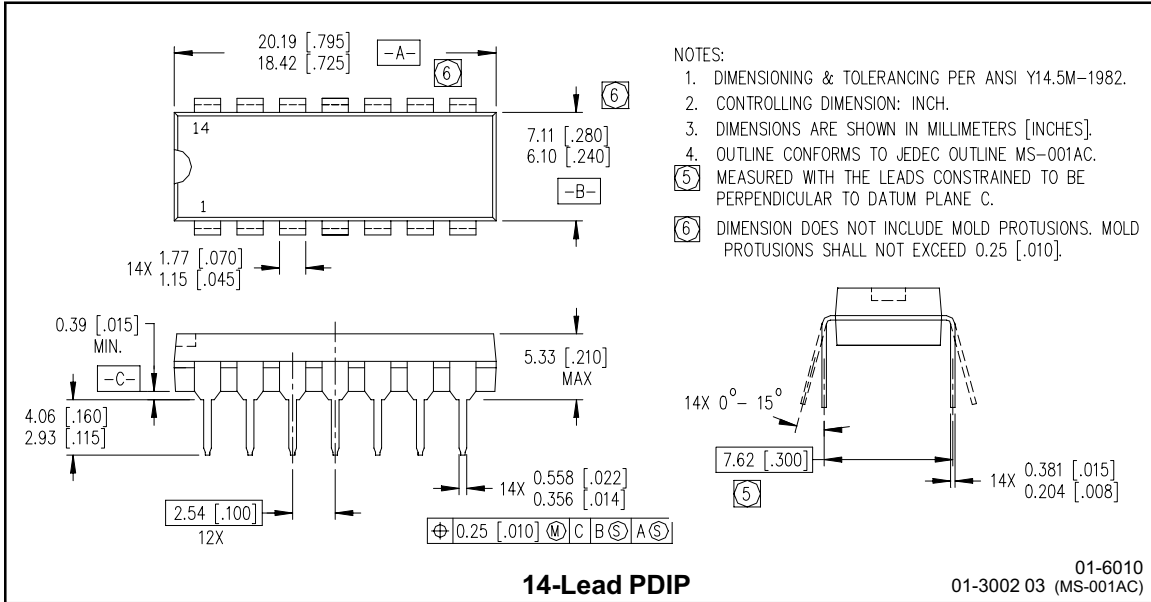
IR2183(4)(S) & (PbF)

International
IR Rectifier

Case outlines

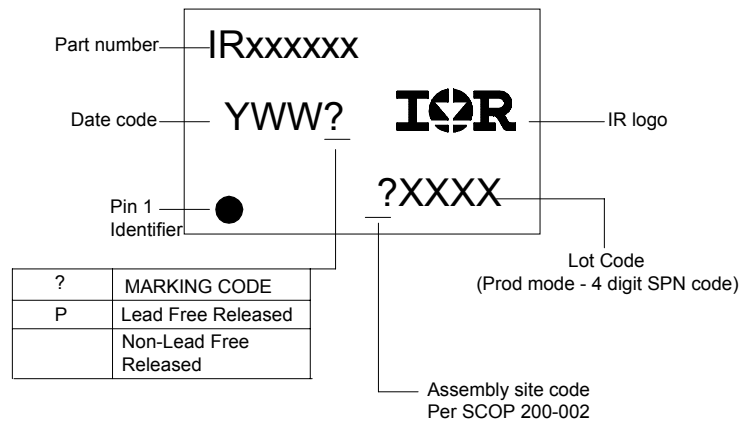


IR2183(4)(S) & (PbF)



IR2183(4)(S) & (PbF)

LEADFREE PART MARKING INFORMATION



ORDER INFORMATION

Basic Part (Non-Lead Free)

8-Lead PDIP IR2183 order IR2183
 8-Lead SOIC IR2183S order IR2183S
 14-Lead PDIP IR21834 order IR21834
 14-Lead SOIC IR21834 order IR21834S

Leadfree Part

8-Lead PDIP IR2183 order IR2183PbF
 8-Lead SOIC IR2183S order IR2183SPbF
 14-Lead PDIP IR21834 order IR21834PbF
 14-Lead SOIC IR21834 order IR21834SPbF