



SY8008A/SY8008B/SY8008C

High Efficiency 1.5MHz, 0.6A/1A/1.2A Synchronous Step Down Regulator *Preliminary Spec*

General Description

The SY8008A, SY8008B and SY8008C are high-efficiency 1.5MHz synchronous step-down DC-DC regulator ICs capable of delivering up to 1.2A output currents. The SY8008 family operate over a wide input voltage range from 2.5V to 5.5V and integrate main switch and synchronous switch with very low $R_{ds(on)}$ to minimize the conduction loss.

Low output voltage ripple and small external inductor and capacitor sizes are achieved with 1.5MHz switching frequency. This along with small SOT-23/TSOT-23 footprint provides small PCB area application.

Applications

- Portable Navigation Device
- Smart phone
- USB Dongle
- Set Top Box
- Media Player

Features

- low $R_{ds(on)}$ for internal switches (top/bottom)
 - SY8008A: 300m Ω /250m Ω , 0.6A
 - SY8008B: 250m Ω /200m Ω , 1A
 - SY8008C: 200m Ω /150m Ω , 1.2A
- 2.5-5.5V input voltage range
- 1.5MHz switching frequency minimizes the external components
- Internal softstart limits the inrush current
- 100% dropout operation
- RoHS Compliant and Halogen Free
- Compact package: SOT23-5/ TSOT23-5 pin

Ordering Information

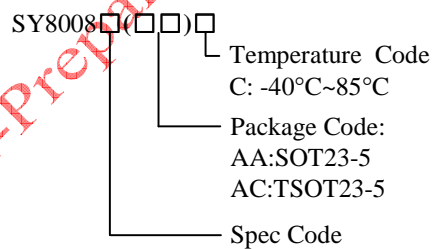

Typical Applications

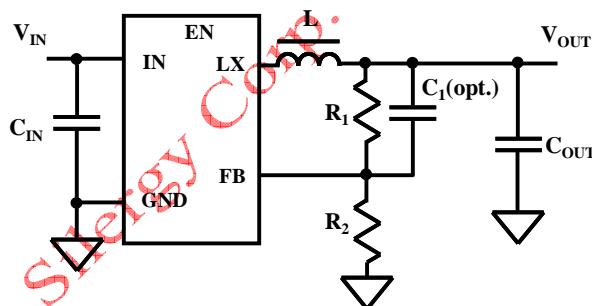

Figure 1

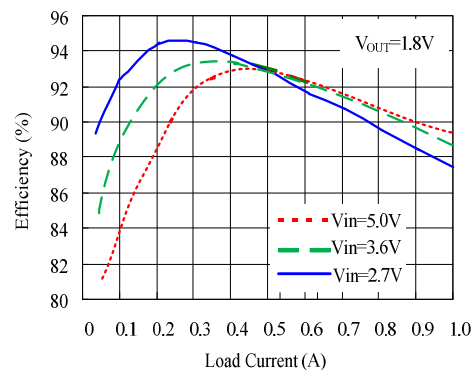
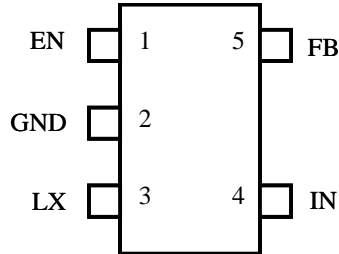

Figure 2. Efficiency vs Load Current



SY8008A/SY8008B/SY8008C

Pinout (top view)



(SOT23-5, TSOT23-5)

Top mark: **AAxyz** for SY8008AAAC, **ABxyz** for SY8008BAAC, **ACxyz** for SY8008CAAC,
BLxyz for SY8008AACC, **BGxyz** for SY8008BACC

(Device code: AA for SY8008AAAC, etc., *x=year code, y=week code, z=lot number code*)

Pin Name	Pin Number	Pin Description
EN	1	Enable control. Pull high to turn on. Do not float.
GND	2	Ground pin
LX	3	Inductor pin. Connect this pin to the switching node of inductor
IN	4	Input pin. Decouple this pin to GND pin with at least 1uF ceramic cap
FB	5	Output Feedback Pin. Connect this pin to the center point of the output resistor divider (as shown in Figure 1) to program the output voltage: $V_{out}=0.6*(1+R1/R2)$. Add optional $C_1(10p-47pF)$ to speed up transient response.

Absolute Maximum Ratings (Note 1)

Supply Input Voltage	6.0V
Enable, FB Voltage	$V_{IN} + 0.6V$
Power Dissipation, P_D @ $T_A = 25^\circ C$ SOT23-5, TSOT23-5	0.4W
Package Thermal Resistance (Note 2)	
SOT23-5, TSOT23-5, θ_{JA}	250°C/W
SOT23-5, TSOT23-5, θ_{JC}	130°C/W
Junction Temperature Range	150°C
Lead Temperature (Soldering, 10 sec.)	260°C
Storage Temperature Range	-65°C to 150°C
ESD Susceptibility (Note 2)	
HBM (Human Body Mode)	2kV
MM (Machine Mode)	200V

Recommended Operating Conditions (Note 3)

Supply Input Voltage	2.5V to 5.5V
Junction Temperature Range	-40°C to 125°C
Ambient Temperature Range	-40°C to 85°C



SY8008A/SY8008B/SY8008C

Electrical Characteristics

($V_{IN} = 3.6V$, $V_{OUT} = 2.5V$, $L = 2.2\mu H$, $C_{OUT} = 10\mu F$, $T_A = 25^\circ C$, $I_{MAX} = 1A$ unless otherwise specified)

Parameter	Symbol	Test Conditions	Min	Typ	Max	Unit
Input Voltage Range	V_{IN}		2.5		5.5	V
Shutdown Current	I_{SHDN}	EN=0		0.1	1	μA
Feedback Reference Voltage	V_{REF}		0.588	0.6	0.612	V
FB Input Current	I_{FB}	$V_{FB} = V_{IN}$	-50		50	nA
PFET RON	$R_{DS(ON),P}$	SY8008A		0.3		Ω
		SY8008B		0.25		Ω
		SY8008C		0.2		Ω
NFET RON	$R_{DS(ON),N}$	SY8008A		0.25		Ω
		SY8008B		0.2		Ω
		SY8008C		0.15		Ω
PFET Current Limit	I_{LIM}	SY8008A	0.8			A
		SY8008B	1.2			A
		SY8008C	1.5			A
EN rising threshold	V_{ENH}		1.5			V
EN falling threshold	V_{ENL}				0.4	V
Input UVLO threshold	V_{UVLO}			2.5		V
UVLO hysteresis	V_{HYS}			0.1		V
Oscillator Frequency	F_{OSC}	$I_{OUT} = 100mA$		1.5		MHz
Min ON Time				50		ns
Max Duty Cycle			100			%
Thermal Shutdown Temperature	T_{SD}			160		$^\circ C$

Note 1: Stresses listed as the above "Absolute Maximum Ratings" may cause permanent damage to the device. These are for stress ratings. Functional operation of the device at these or any other conditions beyond those indicated in the operational sections of the specifications is not implied. Exposure to absolute maximum rating conditions for extended periods may remain possibility to affect device reliability.

Note 2: θ_{JA} is measured in the natural convection at $T_A = 25^\circ C$ on a low effective single layer thermal conductivity test board of JEDEC 51-3 thermal measurement standard. Pin 2 of SOT-23-5/TSOT-23-5 packages is the case position for θ_{JC} measurement.

Note 3: The device is not guaranteed to function outside its operating conditions.

SOT23-5 Package outline & PCB layout design

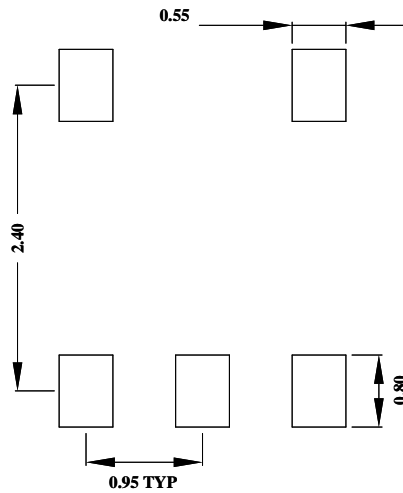

Recommended Pad Layout

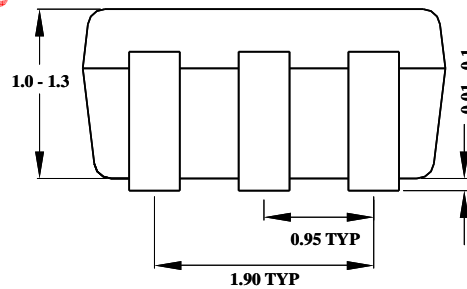
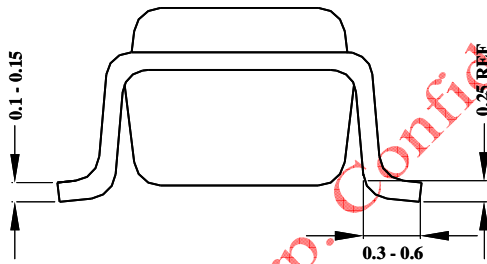
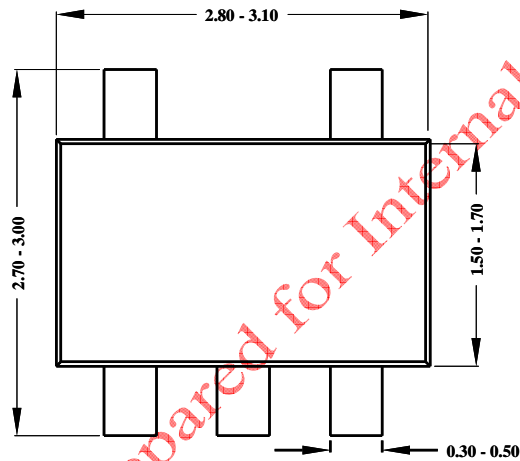

Notes: All dimensions are in millimeters.
All dimensions don't include mold flash & metal burr.

TSOT23-5 Package outline & PCB layout design

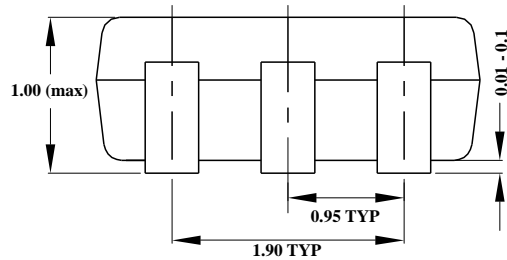
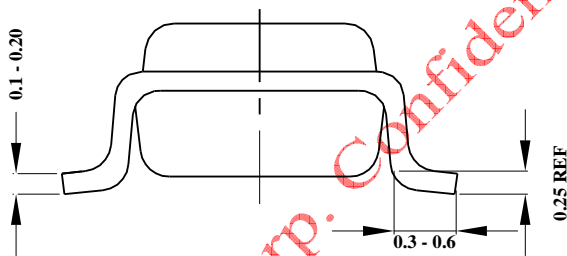
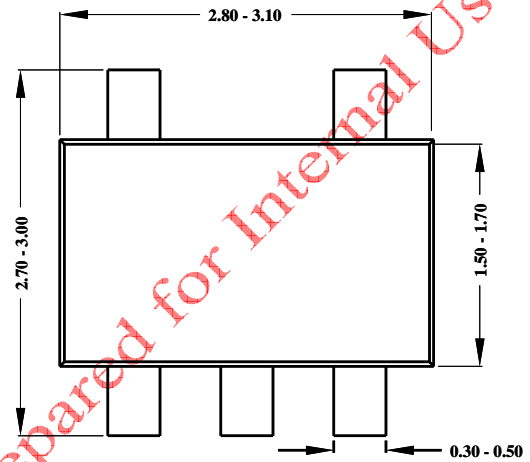
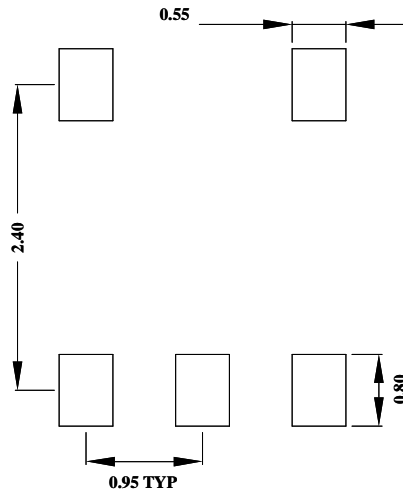

Notes: All dimensions are in millimeters.
All dimensions don't include mold flash & metal burr.